

## DT-200/002 model

### Characteristic

Wire resistor type DT-200/002 is composed of three serial connected resistors. These type of resistors are used in car blower unit for step by step control of fan motor speed. All DT-200/002 have a thermal fuse which disconnects blower circuit in emergency situations, after exceeding the specified safety temperature.

Parameter	Value
Operating voltage	24 V
Resistance tolerance	±10 %

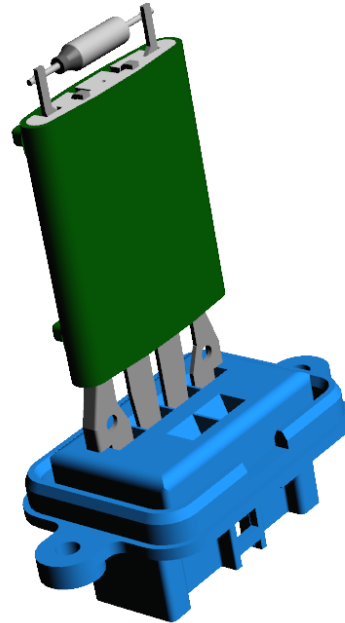

### Schematic diagram

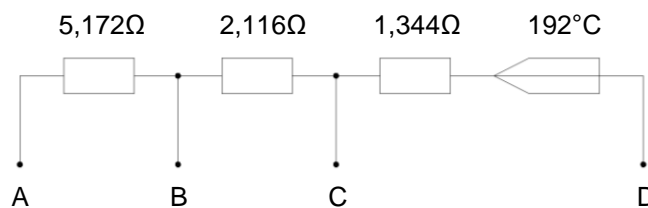

### Dimensions

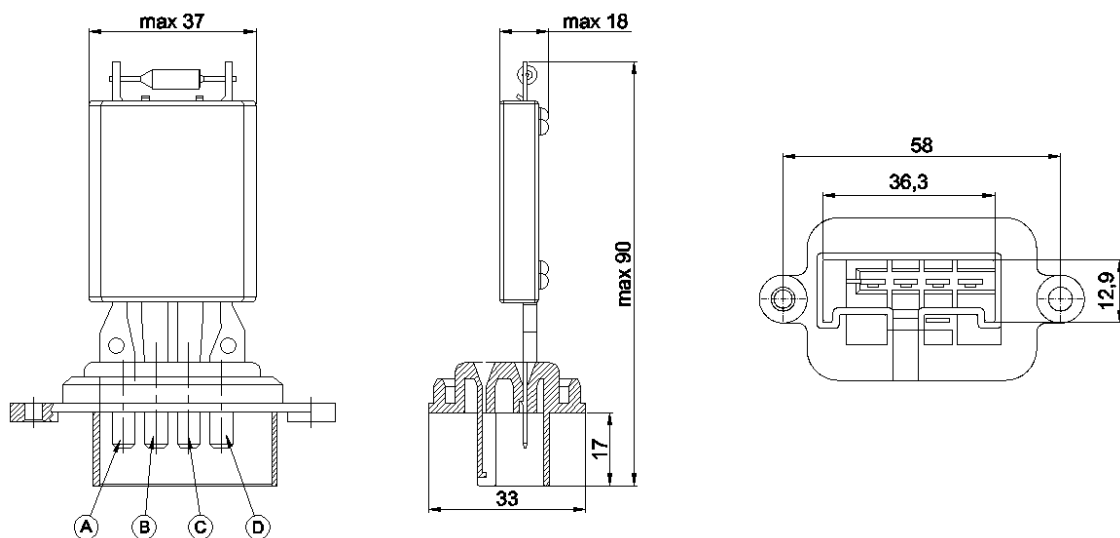

### TELPOD S.A.

str. Pilsudskiego 63A  
32-050 Skawina  
[www.telpod.pl](http://www.telpod.pl)

Technical division: +48 (0)12 257 10 12  
Sales division: +48 (0)12 257 10 35  
fax: +48 (0)12 257 10 13  
e-mail: [telpod@telpod.pl](mailto:telpod@telpod.pl)

date: 04 / 2015  
Copyright 2015 by Telpod